

Fail-Safe actuator used in typical Fire and Smoke damper applications

- Torque motor 70 in-lb [8 Nm]
- Nominal voltage AC 230 V
- Control On/Off
- @ 350°F [177°C] for 30 min
- 15 s, 15 s Motor/Fail-safe



5-year warranty

Technical data

Electrical data	Nominal voltage	AC 230 V
	Nominal voltage frequency	50/60 Hz
	Nominal voltage range	AC 207...253 V
	Power consumption in operation	27 VA
	Power consumption in rest position	5 W, 9 VA (60 Hz 6.5 VA), End stop 55 VA, 0.25 A slow blow fuse *
	Connection supply	3 Leads 32" [0.9 m], 18 AWG with 1/2" NPT conduit connector
	Overload Protection	electronic throughout 0...95° rotation
	Electrical Protection	grounded enclosure, 230 V
	Functional data	Torque motor
Direction of motion motor		selectable by ccw/cw mounting
Direction of motion fail-safe		reversible with cw/ccw mounting
Angle of rotation		95°
Running Time (Motor)		15 s / 90°
Running time motor note		between 32...350°F [0...177°C], <15 s at rated voltage & torque
Running time fail-safe		15 s
Noise level, motor		45 dB(A)
Noise level, fail-safe		62 dB(A)
Position indication	Mechanical	
Safety data	Degree of protection IEC/EN	IP40
	Degree of protection NEMA/UL	NEMA 1
	Enclosure	UL Enclosure Type 1
	Agency Listing	cULus acc. to UL60730-1A/-2-14, CAN/CSA E60730-1:02 NYC Department of Buildings MEA 197-07-M
	Quality Standard	ISO 9001
	UL 2043 Compliant	Suitable for use in air plenums per Section 300.22(C) of the NEC and Section 602 of the IMC
	Ambient humidity	Max. 95% RH, non-condensing
	Ambient temperature	32...122°F [0...50°C]
	Storage temperature	-40...176°F [-40...80°C]
	Servicing	maintenance-free
Weight	Weight	6.8 lb [3.1 kg]

Technical data

Materials	Housing material	galvanized steel
	Gears	steel, permanently lubricated

Footnotes † UL File XAPX.E108966

Safety notes

- * Neither UL nor Belimo require local over-current protection. The FSNF actuators draw higher peak current when driving against any type of stop. If used, this requires the value of a local fuse or breaker to be increased to avoid nuisance opening or tripping. A 2.5 A slow blow should be used for AC 24 V. A 0.5 A slow blow should be used for AC 120 V. A 0.25 A slow blow should be used for 230 V and a 0.3 A slow blow for AC 208 V. Transformers: Note that while a 24 V 100 VA transformer would handle 2 actuators, a 4 A breaker or plug fuse is insufficient. A 5 A slow blow would be required.
- Belimo Fire & Smoke actuators have passed the AMCA 520 and UL 555S Long Term Holding test. No special cycling is required during prolonged periods when actuator is driven open and held there. Periodic testing of dampers and actuators per local codes and NFPA 80 and NFPA 105 are required.
- The actuator contains no components which the user can replace or repair. A 1/2" threaded connector is standard. FSNFxx-FC models have a 3/8" Flex Connector. Other than the connector, these actuators are identical to the conduit connector version.

Product features

Application	The FS series of spring-return actuators are designed for the operation of UL555 and UL555S listed fire/smoke dampers in ventilation and air-conditioning systems.
Operation	The actuator is mounted in its fail safe position with the damper blade(s) typically closed. Upon applying power, the actuator drives the damper to the open position. The internal spring is tensioned at the same time. If the power supply is interrupted, the spring moves the damper back to its fail-safe position.
Typical specification	All smoke and combination fire and smoke dampers shall be provided with Belimo FSTF, FSLF, FSNF, or FSAF series actuators. All substitutions must be approved before submission of bid. Damper and actuator shall have UL555S Listing for 250°F and/or 350°F. Actuator shall have been tested to UL2043 per requirements of IMC 602.2 and NEC 300.22 (c). Where position indication is required -S models with auxiliary switches shall be provided.

Accessories



Electrical accessories	Description	Type
	Thermoelectric tripping device, Duct inside temperature 165°F	BAE165 US
	Auxiliary switch 2x SPDT	S2A-F US
Mechanical accessories	Description	Type
	Anti-rotation bracket, for AF / NF	AF-P
	End stop indicator for AF / NF	IND-AF2
	Shaft clamp for AF..	K4-1 US
	Actuator arm, clamping range ø10...20 mm	KH-AF KH-AF-1 US SH8
	Angle of rotation limiter for Classic AF/NF.	ZDB-AF2 US
	Mounting bracket for AF..	ZG-100
	Mounting bracket for AF / NF	ZG-101
	Crank arm adapter kit Incl. mounting hardware	ZG-AF US

Accessories

Description	Type
	ZG-AF108
	ZG-DC1
	ZG-DC2
Weather shield 13x8x6" [330x203x152 mm] (LxWxH)	ZS-100
Weather shield 406x213x102 mm [16x8-3/8x4"] (LxWxH)	ZS-150
Explosion proof housing 16x10x6.435" [406x254x164 mm] (LxWxH), UL and CSA, Class I, Zone 1&2, Groups B, C, D, (NEMA 7), Class III, Hazardous (classified) Locations	ZS-260
Weather shield 17-1/4x8-3/4x5-1/2" [438x222x140 mm] (LxWxH), NEMA 4X, with mounting brackets	ZS-300

Electrical installation

 **INSTALLATION NOTES**

-  Provide overload protection and disconnect as required.
-  Actuators may be powered in parallel. Power consumption must be observed.
-  Ground present on some models.

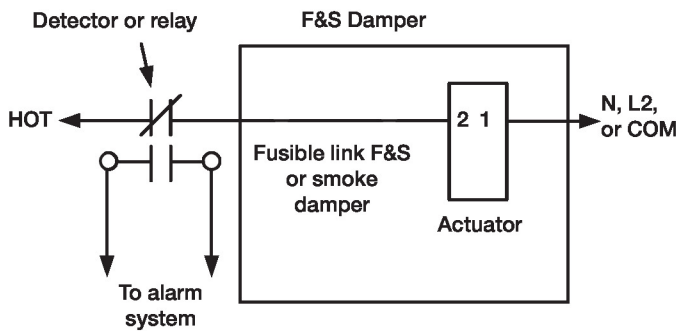

Typical smoke or fusible link damper wiring

Wiring diagrams

AC 230 V

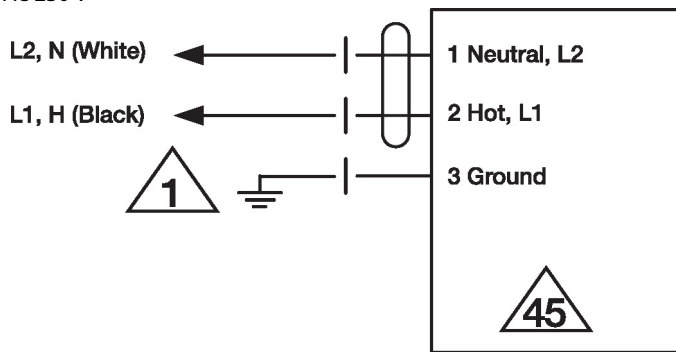

Electrical installation

Wiring diagrams

Typical containment damper control wiring
 Detector or relay F&S Damper

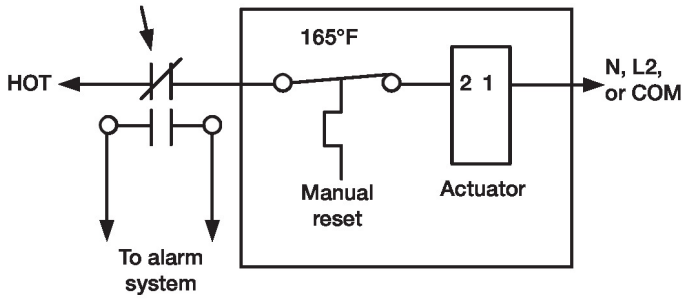

Typical smoke or fusible link damper wiring
 Detector or relay F&S Damper

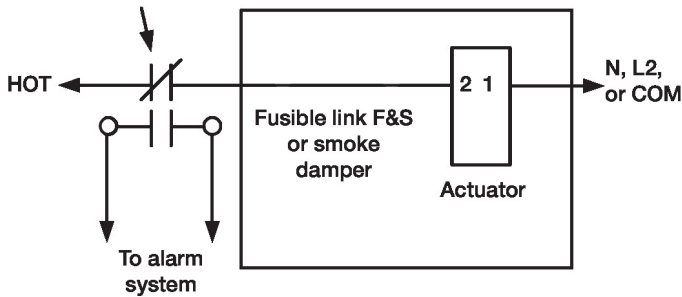

Parallel Actuator Wiring

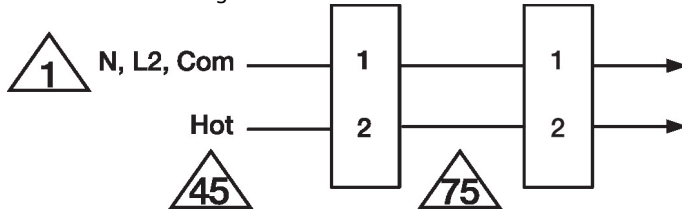

Dimensions

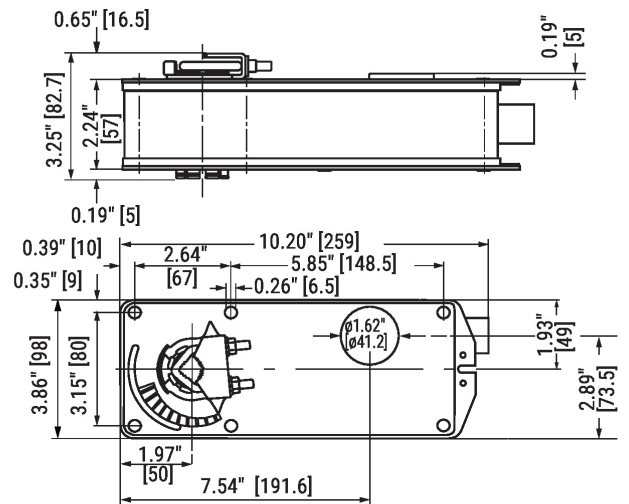

Standard:
 1/2" to 1.05"

Optional*
 3/8" to 3/4"

*with K4 US clamp